



## GNM 26

### DC Motors

with permanent magnet field

Designs with brake with 1000mm connection cord

Motor series GNM 26  
up to 50 Watts output power  
with + without parking brake

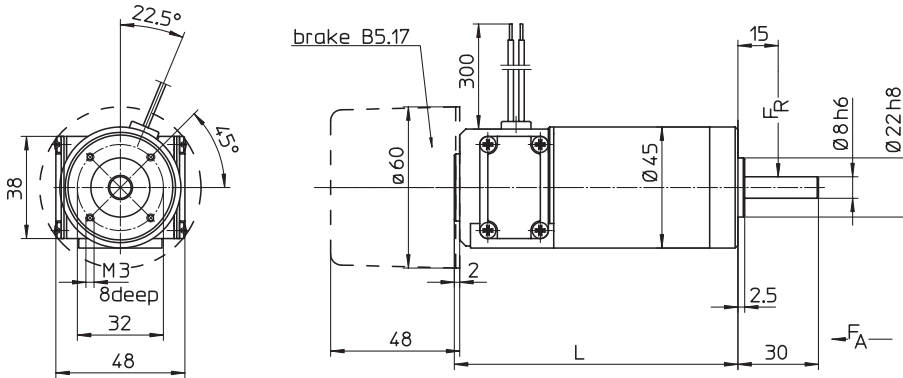

Type	Dimension L
GNM 2636	107
GNM 2670	151

**Operation characteristics:**

n - Speed  
η - Efficiency  
P<sub>1</sub> - Input power  
P<sub>2</sub> - Output power

GNM2636, 24V, 3000rpm

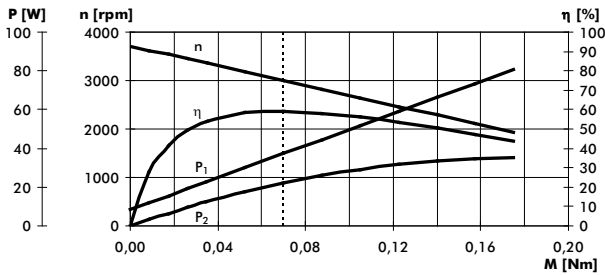

GNM2670, 24V, 3000rpm

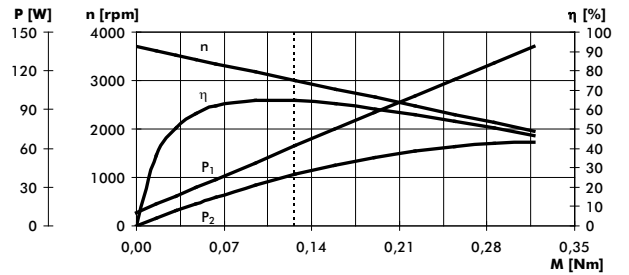

GNM2636, 24V, 4000rpm

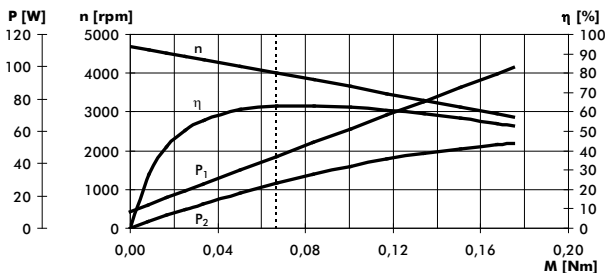

GNM2670, 24V, 4000rpm

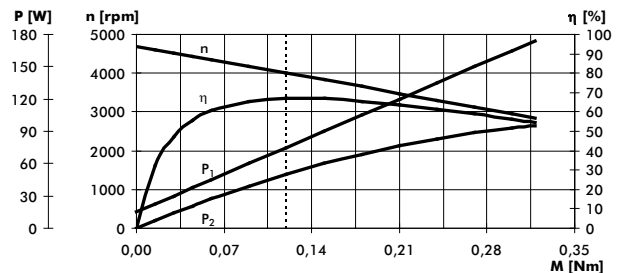

**Control characteristics :**

n=f(M) - Speed as a torque function  
n=f(U) - Speed as a supply voltage function

GNM2636, 24V, 3000rpm  
GNM2670, 24V, 3000rpm

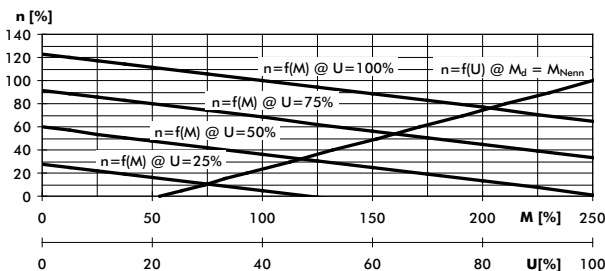

GNM2636, 24V, 4000rpm  
GNM2670, 24V, 4000rpm

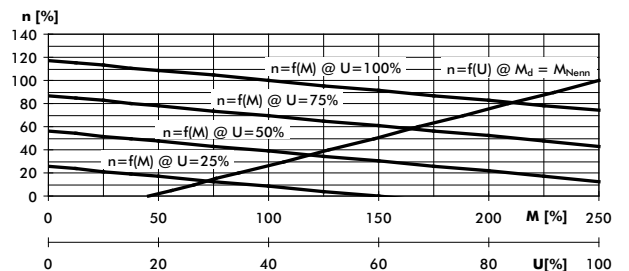

edition 01.11

type series	GNM 2636		GNM 2670	
	3000	4000	3000	4000
nominal speed	rpm	24	24	24
nominal voltage	V	1,6	2,6	3,1
nominal current	A	22	40	50
nominal power	W			
operation acc. to VDE 0530		S1	S1	S1
protection acc. to VDE 0530		IP 41	IP 41	IP 41
connection		free leads reversible	free leads reversible	free leads reversible
rotating direction		B 14	B 14	B 14
design				
<b>mechanical data:</b>				
mass moment of inertia	kgm <sup>2</sup>	0,07	0,067	0,127
nominal torque	Nm	0,33	0,4	0,61
starting torque	Nm	0,09	0,09	0,16
max. continuous torque at stall	Nm	102	104	55
speed regulation constant	N <sup>-1</sup> cm <sup>-1</sup> rpm	13,3	13,6	13,2
mechanical time constant	ms	0,02	0,02	0,025
friction torque	Nm			
rotor weight	kg	0,19	0,19	0,3
motor weight	kg	0,58	0,58	0,95
motor weight incl. parking brake	kg	0,78	0,78	1,15
ball bearings		608/607	608/607	608/607
F <sub>r</sub> (allowable radial shaft load)		80	80	80
F <sub>A</sub> (allowable axial shaft load)		32	32	32
<b>electrical data:</b>				
armature resistance	Ω	3,1	1,9	1,6
armature inductance	mH	3,1	1,9	1,7
terminal resistance	Ω	3,6	2,4	2
voltage constant	V/1000 rpm	6,1	4,9	6,2
torque constant	Nm/A	0,058	0,047	0,059
starting current	A	6,7	10	12
max. peak current <sup>1)</sup>	A	14,5	18,5	26
electrical time constant	ms	0,86	0,79	0,85
<b>thermal data:</b>				
max. ambient temperature	°C	40	40	40
insulation class acc. to VDE 0530		F	F	F
thermal time constant	min	27	27	27
temperature-rise without cooling	K/W	6,6	6	4,7
<b>parking brake B 5.17:</b>				
nominal voltage	V	24	24	24
nominal current	A	0,3	0,3	0,3
static break torque (motor shaft)	Nm	0,5	0,5	0,5
max. number of operations per hour		2000	2000	2000
Tolerances acc. to standard VDE 0530. ± 10 % is valid for not VDE mentioned tolerances.				
The values mentioned in the table are valid for supply with DC voltage with allowable harmonic content up to 5%. For undulatory current with increased harmonic content the rated motor values must be multiplied by 0,7.				
<sup>1)</sup> The values are valid for operation in temperature-ranges from 0 up to 40°C and it is not allowed to exceed them, even not for a short-time, to avoid magnet-weakening.				
<ul style="list-style-type: none"> <li>● Motors also available with incremental encoder DIT 1.</li> <li>● Motors also available in protection IP 54 and/or with device plug DIN 43650.</li> <li>● Design with brake in protection IP 54 and with cable connection.</li> </ul>				
<ul style="list-style-type: none"> <li>● Motor GNM 2636A 24 V, 3000 rpm, 22 W</li> <li>● Special designs on request.</li> </ul>				
design-changes reserved				